

FITTING INSTRUCTION

Clamp mark in acc. with		Cables joining
ISO	PN	
1	L	Left directional lights
2	+	Rear fog lights
3	31	Ground
4	R	Right directional lights
5	58R	Right side parking lights
6	54	Stoplights
7	58L	Left side parking lights

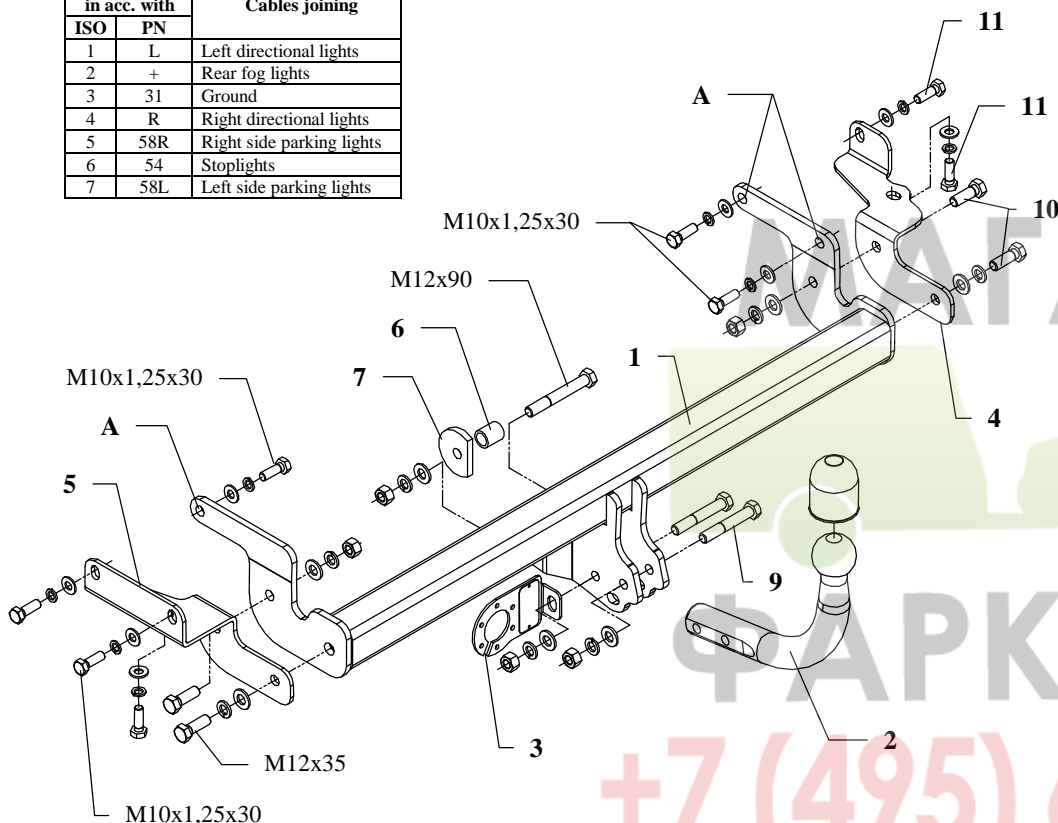

This towbar is designed to assembly in following cars:
MITSUBISHI LANCER SEDAN, produced since 2003 till 2007,
 catalogue no. **Z35** and is prepared to tow trailers max total weight **1200 kg**
 and max vertical load **60 kg**.

From manufacturer

Thank you for buying our product. Their reliability has been confirmed in many tests. Reliability of towbar depends also on correct assembly and right operation. For this reasons we kindly ask to read carefully this instruction and apply to hints.

The towbar should be install in points described by a car producer.

The instruction of the assembly

1. Cut out the lower fragment of the bumper, as shown on the fig. 2.
2. Put main bar of the towbar to the car frame in that way so holes (pos. A) be covered with holes in frame and fix using bolts M10x1,25x30 mm (pos. 11) - fix loosely.
3. To the left chassis member put element (pos. 5) and fix using bolts M10x1,25x30mm (pos. 11) and M12x35mm (pos. 10) – see figure 1.
4. To the right chassis member put element (pos. 4) and fix using bolts M10x1,25x30mm (pos. 11) and M12x35mm (pos. 10) – see figure 1.
5. Through hole (pos. B) of the towbar fix with original towing eye – use truncate washer (pos. 7), distance sleeve $\varnothing 21\text{mm}$, L=25mm (pos. 6) and bolt M12x90mm (pos. 8) – see figure 3.
6. Fix tow-ball (pos. 2) with socket plate (pos. 3) using bolts M12x75mm (pos. 9) from accessories.
7. Tighten all bolts according to the torque shown in the table.
8. Connect electric wires of 7-poles socket according to the instruction of the car. (Recommend to make at authorized service station).
9. Complete paint layer damaged during installation.

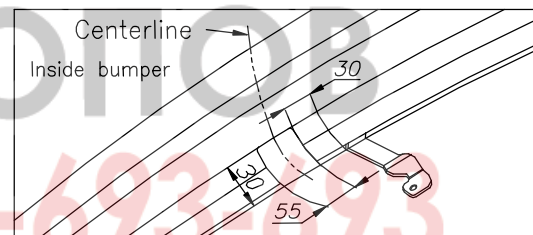

Fig. 2. Bumper cut out

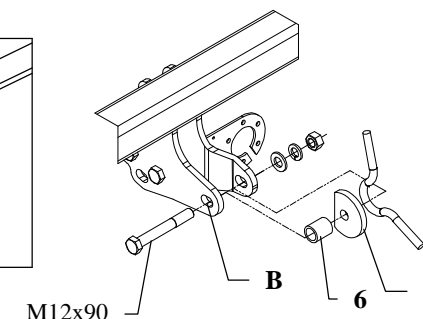

Fig. 3. Rear view

Torque settings for nuts and bolts (8,8):

M6 - 11 Nm	M8 - 25 Nm	M10 - 50 Nm
M12 - 87 Nm	M14 - 138 Nm	M16 - 210 Nm











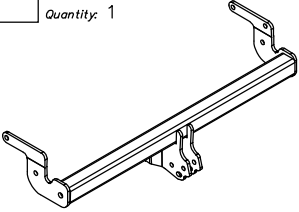

NOTE

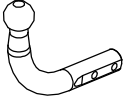
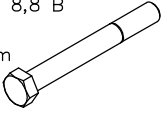
After install the towbar you should get adequate note in registration book (at authorised service station).The car should be equipped with:

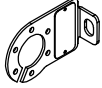
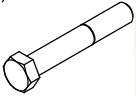
- Indicators
- Tow mirrors

After 1000km of exploitation check all bolts and nuts. The ball of towbar must be always kept clear and conserve with a grease.

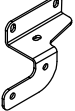
Towbar accessories:

Pos. 1 Name: Main bar Quantity: 1 	Pos. 6 Name: Distance sleeve Quantity: 1 Dim.: Ø21x2,65mm L=25mm 	Pos. 12 Name: Nut 8 B Quantity: 5 Dim.: M12 
	Pos. 7 Name: Truncate washer Quantity: 1 Dim.: Ø58xØ13x8mm 	Pos. 13 Name: Plain washer Quantity: 7 Dim.: Ø 13 mm 
Pos. 2 Name: Tow ball Quantity: 1 	Pos. 8 Name: Bolt 8,8 B Quantity: 1 Dim.: M12x90mm 	Pos. 14 Name: Plain washer Quantity: 8 Dim.: Ø 10,5 mm 
Pos. 3 Name: Socket plate Quantity: 1 	Pos. 9 Name: Bolt 8,8 B Quantity: 2 Dim.: M12x75mm 	Pos. 15 Name: Spring washer Quantity: 7 Dim.: Ø 12,2 mm 
Pos. 4 Name: Right handle Quantity: 1 	Pos. 10 Name: Bolt 8,8 B Quantity: 4 Dim.: M12x35mm 	Pos. 16 Name: Spring washer Quantity: 8 Dim.: Ø 10,2 mm 
Pos. 5 Name: Left handle Quantity: 1 	Pos. 11 Name: Bolt 8,8 B Quantity: 8 Dim.: M10x1,25x30mm 	Pos. 17 Name: Ball cover Quantity: 1 



PPUH AUTO-HAK S.J.

Produkcja Zaczepów Kulowych
Henryk & Zbigniew Nejman
76-200 SŁUPSK ul. Słoneczna 16K
tel/fax (059) 8-414-414; 8-414-413
E-mail: office@autohak.com.pl
www.autohak.com.pl

Towing hitch (without electrical set)

Class: A50-X Cat. no. **Z35**

Designed for:

Manufacturer: **MITSUBISHI**

Model: **LANCER**

Type: **SEDAN**

produced since 2003 till 2007

Technical data:

D-value: 6,2 kN

maximum trailer weight: **1200 kg**

maximum vertical cup load: **60 kg**

Approval number according to Directive 94/20/EC: e20*94/20*0124*00

Foreword

This towbar is designed according to rules of safety traffic regulations. The towing hitch is a safety component and can be install only by qualified personnel. Any alteration or conversion of the towing hitch is prohibited and would lead to cancellation of design certification. Remove insulating compound and underseal from vehicle (if present) in the area of the matting surfaces of the towing hitch. The vehicle manufacturer's specifications regarding trailer load and max. vertical cup load are decisive for driving whereat values for the towing hitch cannot be exceeded.

D-value formula:

$$\frac{\text{Max trailer weight [kg]} \times \text{Max vehicle weight [kg]}}{\text{Max trailer weight [kg]} + \text{Max vehicle weight [kg]}} \times \frac{9,81}{1000} = D \text{ [kN]}$$